



Counting Chambers



sedgewick rafter cell

S50 - plastic sedgewick rafter counting chamber

pattern	description	order code
S50	Sedgewick Rafter Counting Chamber [plastic] Includes 1 cover glass	02C00415

key features

Plastic - economically priced cell

description

An economically priced cell, for one time (or possibly several time) use and for educational/training exercises.

Generally we do not recommend the S50 plastic version for the professional user. The softness of the plastic means it is easily scratched and otherwise damaged. However most laboratories who do use the plastic version see it more as a "throw away" or consumable, which may best suit certain applications.



S52 - glass sedgewick rafter counting chamber

pattern	description	order code
S52	Sedgewick Rafter Counting Chamber [Glass] Includes 1 cover glass	02B00417

key features

Glass - Professional Cell

description

A serious reusable tool for the professional user. The cell is made of high quality optical glass with a chromium surface image. It is intended for continued professional use and whenever using phase contrast.



S51 - spare coverglass for pyser optics sedgewick rafter counting chamber

pattern	description	order code
S51	Cover glass for use with both Glass & Plastic Cells	02C00416

key features

For use with both Glass & Plastic Cells

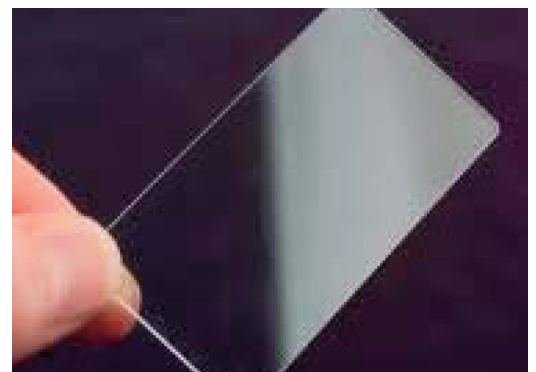

sedgewick-rafter filling method & usage

The cell can be used with either living or preserved material. To fill the cell, place the cover glass across the chamber top (Fig A). This allows the air bubbles to escape during the filling procedure. The sample is then taken into a 1ml wide mouthed pipette and then carefully transferred to the chamber.

Do not overfill the chamber, because the volume of the sample in the chamber must be known exactly and the cover glass must not float free, but held onto the cell walls by surface tension. During counting, water may evaporate from the chamber. To prevent gas bubble formation, a small drop of distilled water may be placed on the slide outside the cell, just touching the cell wall and cover glass. Before the cell count is made the Sedgewick-Rafter chamber should be allowed to stand for at least 15 minutes to allow algae, or other particles, to settle to the bottom.

The Grid Pattern in the base of the chamber assists the counting and calculation process, by clearly defining a known sample volume in 1 μ l blocks Counting in strips is easier, no need to use reticle grids or know the precise area of your field of view.

For precise sample preparation and calculation methods, you should follow your own internal or published procedures.

Filling a Sedgewick-Rafter Chamber

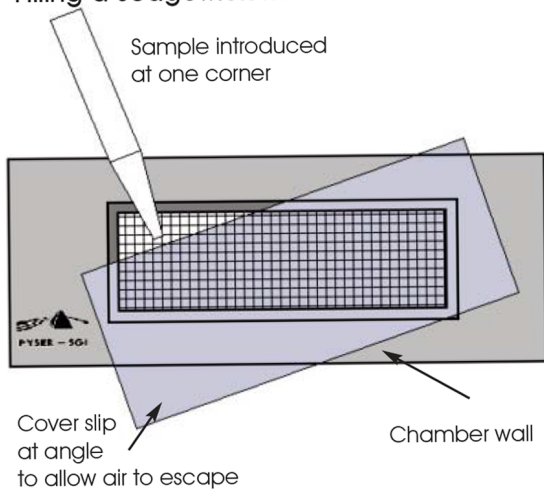

Fig A

cleaning method

To clean the counting chamber: After completing the count, remove the cover glass and clean the counting chamber with water or a mild cleaning solution (10% solution of bleach). Dry the counting chamber with a soft cloth or wipe, or rinse with acetone.

howard mould counting cell

Graticules Optics S60 Howard Cell and associated K20 Cover Glass, is used world wide for mould counting in food quality control applications, such as tomato products and other fruit based preparations.

The special S60 Howard Cell chamber slide in conjunction with the K20 Cover Glass is designed to count mould mycelia.

The S60 Howard Cell is a glass slide 76mm x 35mm with a central circular island and is used for counting mould fibres and spores in fruit juices especially from tomatoes. With the K20 cover glass in place a 0.1mm thickness of liquid is contained over the central island.

The cover glass has 25 calibrated fields of 1.382mm diameter through which to view the particles.

This cover glass removes the necessity of precise adjustment of the microscope magnification and calibration of a special eyepiece reticle in the original Howard Method, making it suitable for use with a modern zoom stereo microscope as well as a conventional compound microscope.

Note: The complete system requires both the cell itself and cover glass. The cell does not come with a cover glass and one must be ordered separately. We recommend ordering one or two extra cover glasses, this way there is always going to be one in reserve.

S60 - howard cell for fruit juices

pattern	description	order code
S60	Howard Cell for Fruit Juices	02C00419

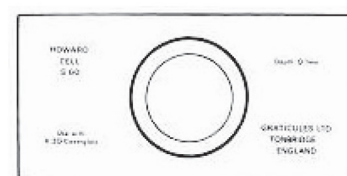

key features

Special Chamber for use with K20 windowed cover slip to count mould fibres and spores

description

The S60 Howard Cell is a glass slide 76mm x 35mm with a central circular island and is used for counting mould fibres and spores in fruit juices especially from tomatoes. With the K20 cover glass in place a 0.1mm thickness of liquid is contained over the central island.

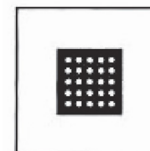

K20 - cover glass

pattern	description	order code
K20	Coverglass for Howard Cell	02C00420

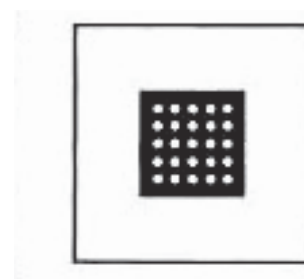

key features

For use with S60 Cell to hold a 0.1mm thickness of liquid for analysis and present known sample volumes for counting

description

When used with the S60 Howard Cell, the K20 cover glass holds in place a 0.1mm thickness of liquid is over the central island for analysis.

The cover glass has 25 calibrated fields of 1.382mm diameter through which to view the particles.

This cover glass removes the necessity of precise adjustment of the microscope magnification and calibration of a special eyepiece reticle in the original Howard Method, making it suitable for use with a modern zoom stereo microscope as well as a conventional compound microscope.

how to use a howard cell - general procedure

The material to be examined should be a pulp. Mix a small quantity with water until the solids of the diluted pulp are between 8.37% and 9.37%. This corresponds to an Abbe refractometer reading at 20°C of 1.3460.

Spread a small drop of the well-mixed sample with the end of a glass rod over the counting chamber.

Place the cover glass on to the counting chamber and carefully press down the shoulder of the chamber until Newton's rings are visible.

Prepared samples containing air bubbles beneath the cover glass or an over-full moat should be discarded.

If using a compound microscope, examine using the X10 eyepiece and the X10 objective.

Howard Mould Counting Cell & Cover Glass

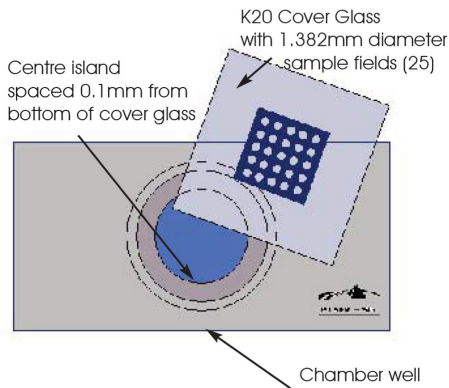

If using a compound microscope, examine using the X10 eyepiece and the X10 objective.

Systematically examine all 25 fields and note those with a presence or absence of mould filaments (hyphae).

A field is regarded as positive if the aggregate length of not more than three filaments present exceed one sixth of the diameter of the field.

This is a general description of how a Howard Cell is used. The results are interpreted as a percentage of positive fields observed in all the fields examined.

Precise interpretation of the results is made by a statistical analysis of the sample and should be carried out in accordance with your own internal or published procedures.

Makler Chamber

The Makler counting chamber is only 10µm deep, which is one tenth the depth of other Haemocytometers, making it the shallowest of known chambers.

This quality chamber is constructed from two pieces of optically flat glass: the first is the chamber, the second the cover glass which has a fine grid pattern of 1mm squares and a centre area further subdivided into 0.1mm squares.

Four quartz pins of precise height hold the cover glass to give an exact trapped specimen depth of 10 µm

makler chamber

pattern	description	order code
Makler	0.01mm deep Semen Counting Chamber	02C00645

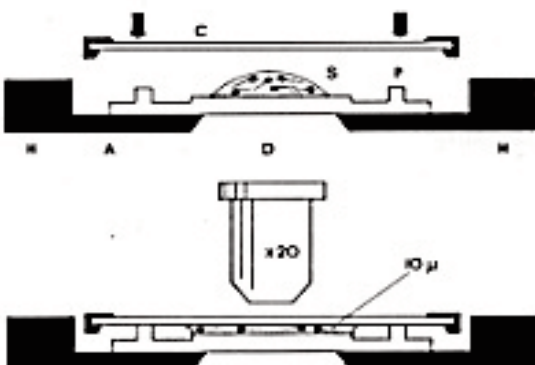
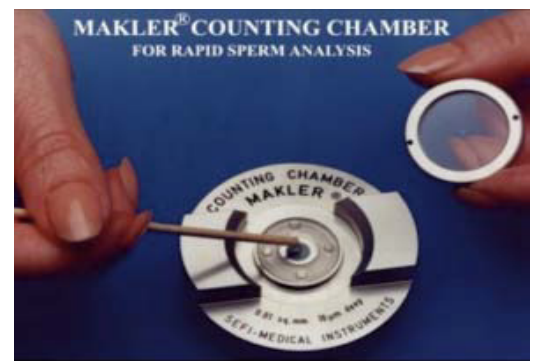

haemocytometry counting chambers

malassez double cell

pattern	description	order code
Malassez	Double Cell 0.2mm	02C00600

key features

For Haemoglobin and Lucocyte counts

description

Standard French Ruling

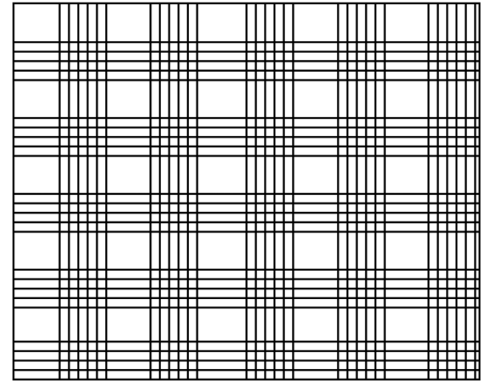

malassez single cell

pattern	description	order code
Malassez	Single Cell 0.2mm	02C00601

key features

For Haemoglobin and Lucocyte counts

description

Standard French Ruling

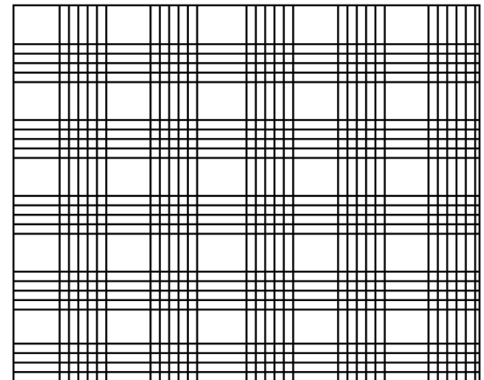

thoma double cell

pattern	description	order code
Thoma	Double Cell 0.1mm	02C00605

key features

For Haemoglobin and Lucocyte counts

description

Standard German Ruling

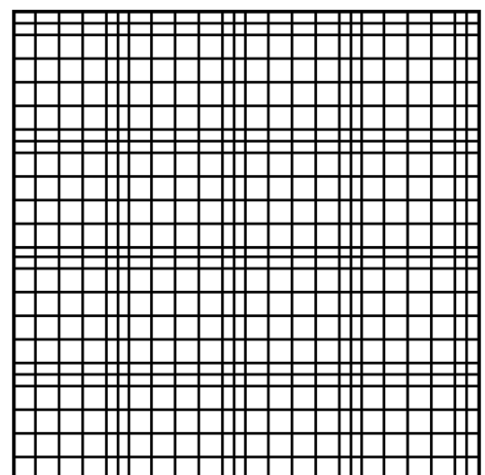

haemocytometry counting chambers

thoma single cell

pattern	description	order code
Thoma	Single Cell 0.1mm	02C00606



key features

For Haemoglobin and Lucocyte counts

description

Standard German Ruling

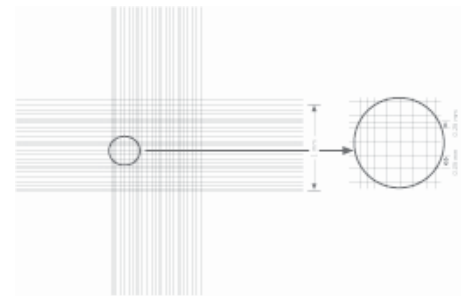

neubauer double cell

pattern	description	order code
Neubauer	Double Cell 0.1mm	02C00610



key features

For Haemoglobin and Lucocyte counts

description

Modified Thoma Ruling

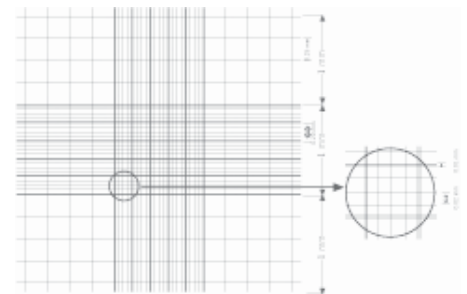

neubauer single cell

pattern	description	order code
Neubauer	Single Cell 0.1mm	02C00611



key features

For Haemoglobin and Lucocyte counts

description

Modified Thoma Ruling

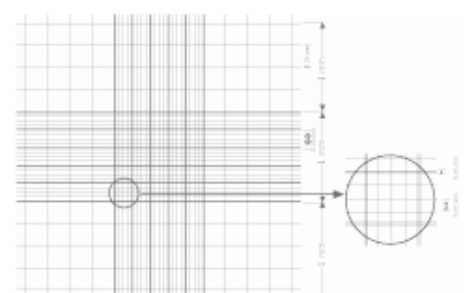

haemocytometry counting chambers

improved Neubauer double cell

pattern	description	order code
Improved Neubauer	Double Cell 0.1mm	02C00616

key features

For Haemoglobin and Lucocyte counts

description

Ruling allows full use of central squares

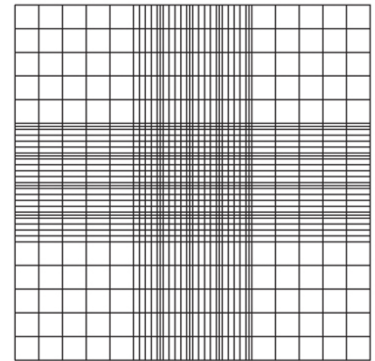

burker

pattern	description	order code
Burker	Double Cell 0.1mm	02C00626

key features

For Haemoglobin and Lucocyte counts

description

For counts in bands

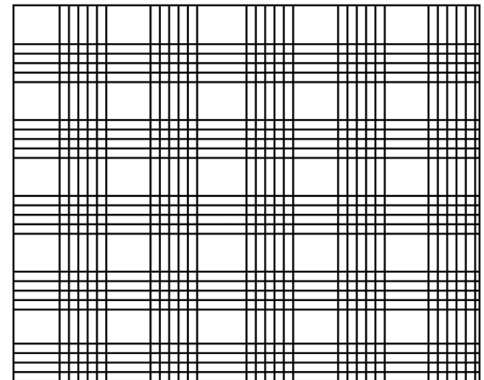

parasitology, cytology & other chambers

nageotte double cell

pattern	description	order code
Nageotte	Double Cell 0.5mm	02C00630

key features

For Urinary cytology, cephalo-rachidien fluid analysis

description

For liquids in poor content (French)

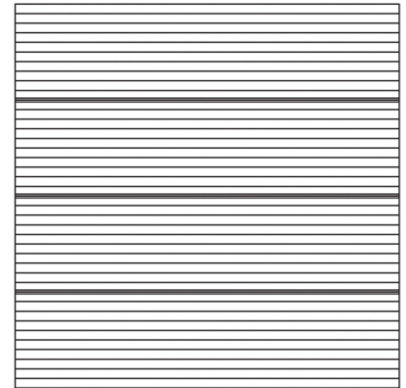

improved mc master double cell

pattern	description	order code
McMaster	Double Cell 1.5mm	02C00650

key features

Parasitology

description

Worm egg counting



Chamber is ruled with 2 x 1 cm squares, each with 10 equal distance vertical lines forming 10 mm squares with 10 equal vertical columns.

helber single round cell

pattern	description	order code
Helber	Single Round Cell 0.02mm	02C00655

key features

Bacteria

description

Slide 1mm thick with Thoma Ruling

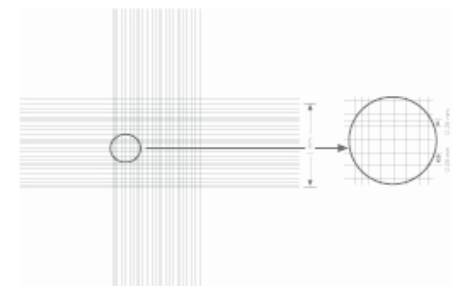

evaluation single round cell

pattern	description	order code
Evaluation	Single Round Cell 0.02mm	02C00660

key features

Bacteria

description

Slide 1mm thick - no ruling

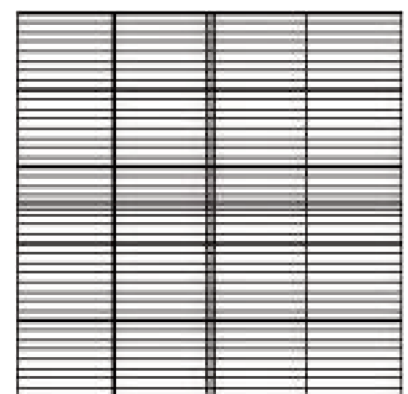

parasitology, cytology & other chambers

semen single round cell

pattern	description	order code
Fertility	Double Cell 0.5mm	02C00630

key features

For Urinary cytology, cephalo-rachidien fluid analysis

description

For counting untreated semen. Ruling of 10 x 10 of 0.1mm squares

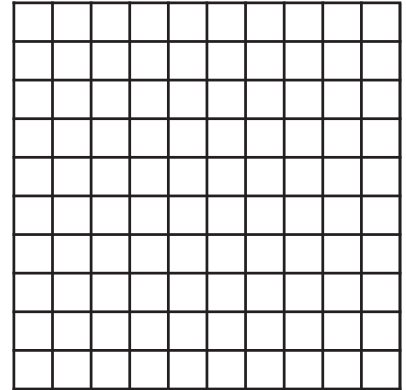



Graticules Optics Ltd

17-19 Morley Road, Tonbridge, Kent, TN9 1RN, UK

Tel +44 (0)1732 360 460

Email sales@graticulesoptics.com

www.graticulesoptics.com

